

# Desk housing PGH MA14/TDS/BG/HG

Item 114912



GO TO PRODUCT

**ingun**<sup>®</sup>

Partner for Future Technology

## Application

Desk housing for vacuum test fixtures MA xxxx for modular test fixture configuration.

## Version

Closed base, without rear panel

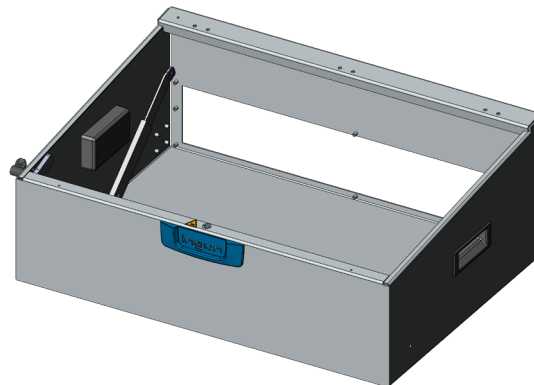

## General data

Product group:	Housing
Series:	PGH-MAxxxx
Type:	MA xx14
Version:	High desk housing with KSG, TDS, base plate
Accessory type:	Additional function
Scope of delivery:	Unassembled
Material:	3.3535
Width:	748 mm [29.4 in]
Height:	278 mm [10.9 in]
Weight:	5.2 kg [11.4 lbs]
Min. temperature:	10 °C [50 °F]
Max. temperature:	60 °C [140 °F]
RoHS-compliant:	Yes

## Compatible with

Manual test fixtures (MA): MA xx14

## Technical data

Length: 521 mm [20.5 in]  
Outer dimensionS (WxDxH): 748 x 521 x 278 (205) mm

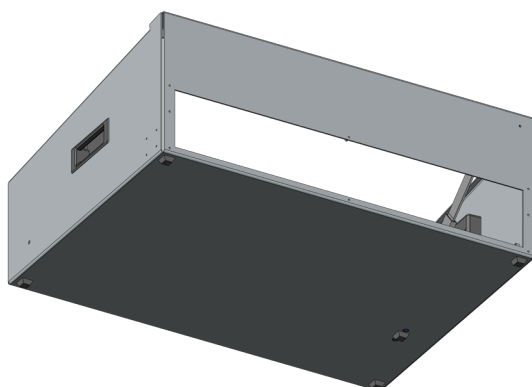

## INGUN Prüfmittelbau GmbH

Max-Stromeyer-Straße 162  
78467, Constance, Germany  
Phone +49 7531 8105-0  
Customer hotline +49 7531 8105-888  
Fax +49 7531 8105-65  
info@ingun.com



Prices and delivery times on request.  
Technical changes reserved. 05/26\_GB

Learn more about  
Test fixture kits

