

# High-current multi-heads

## HCM-667-0001 C02-05000-02

Item HCM-667-0004



GO TO PRODUCT

**ingun**<sup>®</sup>

Partner for Future Technology

## Scaling of current carrying capacity using high-current multi-head solutions

### Contacting of battery cells with higher capacities

- Reliable contact of battery cells
- Modular design enables scalability of current transmission using well-established INGUN products
- Increase in maximum current transmission thanks to cooling feature
- Optional cooling of contact surface using GKS-667
- Voltage monitoring via a central sense contact probe possible
- Temperature measurement of contact surface using TKS-667 is possible
- Easy installation in plate or busbar via the threaded connection

#### Application

HCM-Series is specially developed for the flexible scalability of high-current contacting. The modular design makes it possible to adapt the product characteristics to the application, and therefore always provide the right product for a high variable range of DUTs, as is the case with the contacting of battery cells.

#### Construction

HCM-Products each consist of a base body and several high-current test probes which create a parallel circuit. The functionality can be additionally extended using a centrally positioned sense contact probe or temperature measurement probe with integrated sense tap. Optional air-cooling probes, as an alternative to the current-transmitting test probes, are also available.

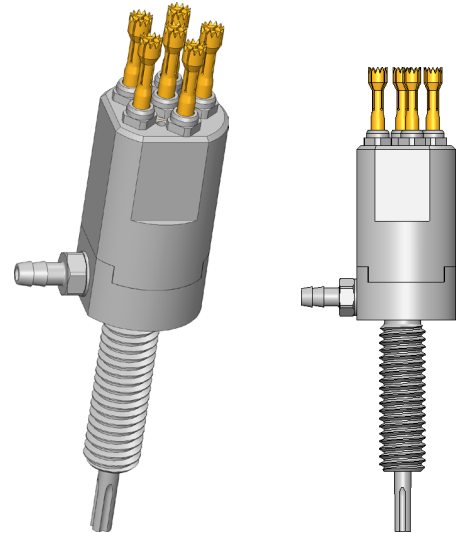

1:1

#### Installation

HCM Products can be installed in a corresponding hole on a probe plate using lock nuts or installed directly in a busbar via a corresponding threaded hole. If a HCM-Product is installed in a non-conductive plate, for example, the current connection can be made at the threaded bolt via a cable lug. The optional sense contact probe, to be connected to the soldering recess provided, and the temperature sensor are dissipated centrally.

#### Note:

The base bodies are designed for either five or eight current-transmitting test probes from the BCP-120, BCP-113 and BCP-667 series with various tip styles, which can be freely configured in terms of both quantity and layout. By combining the modular high-current multi-head solution with BCP-667 probes, which were specifically developed for contacting battery cells with oxidised contact surfaces, it is possible to greatly reduce the power losses that occur during cell production.

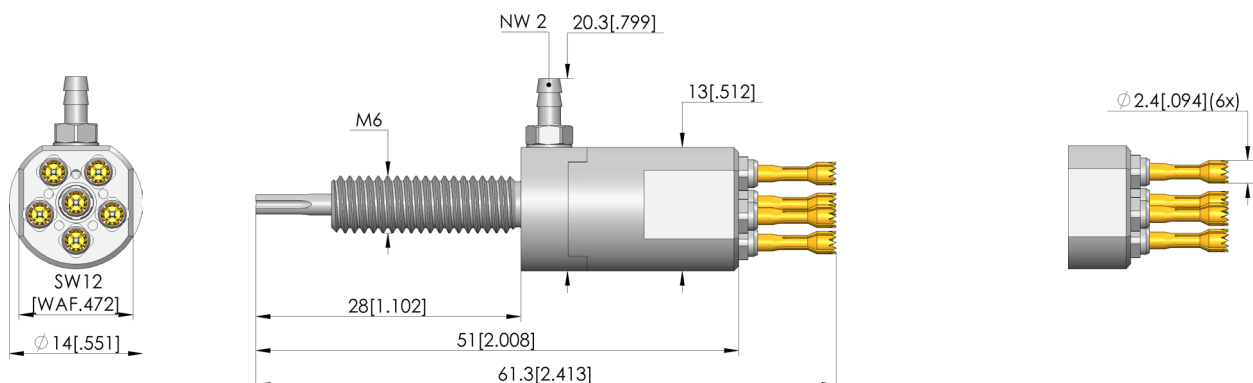

HIGH-CURRENT TEST PROBES

# High-current multi-heads

## HCM-667-0001 C02-05000-02

Item HCM-667-0004



GO TO PRODUCT

**ingun**<sup>®</sup>

Partner for Future Technology

### General data

Screw-in torque max.:	60 cNm [5.31 lbf-in]
Product group:	Standard HSS (screw-in)
Sub-product group:	Standard HSS (screw-in)
Series:	HCM-667
Application rec.:	
Grid:	15 mm [590 mil]
DUT / contact:	
Magnetic:	Yes
Installation type:	Screw-in
Quick-exchange system:	No
Type of test probe connection:	Thread connection
Adjustable installation height:	No
Non-rotating:	Yes
Screw-in torque:	60 cNm [5.31 lbf-in]
Min. temperature:	-100 °C [-148 °F]
Max. temperature:	200 °C [392 °F]
RoHS-compliant:	Yes

### Tip style data

Tip style:	68 expanding tip with front-facing points/cutting edges
Tip diameter:	2.4 mm [.094 in]
Tip style surface:	A gold
Tip style material:	3 CuBe

### Electrical data

Current load capacity / rated current:	300 A
Rated current on copper @ $\Delta T \leq 20$ K:	120 A
Rated current on copper @ $\Delta T \leq 60$ K:	300 A
Rated current on aluminium @ $\Delta T \leq 20$ K:	80 A
Rated current on aluminium @ $\Delta T \leq 60$ K:	150 A
Typical resistance (Ri), connection on plunger:	1 mOhm

### Mechanical data

Total length:	61.3 mm [2.41 in]
Barrel diameter:	14 mm [.551 in]
Maximum stroke:	5.3 mm [.208 in]
Spring pre-load:	8.88 N [31.9 ozf]
Spring force at working stroke:	30 N [107 ozf]
Recommended working stroke:	4 mm [.157 in]

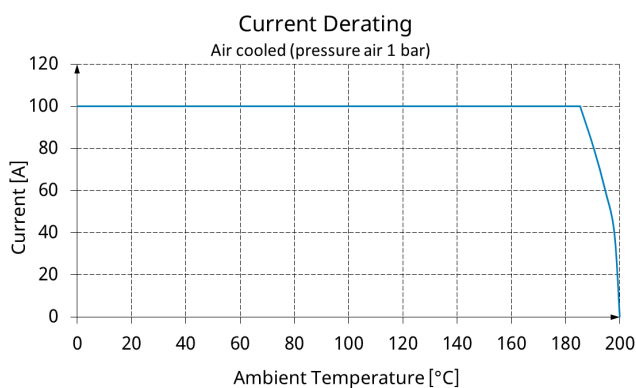
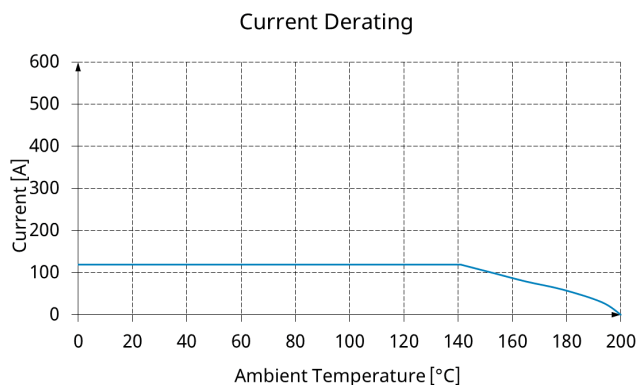
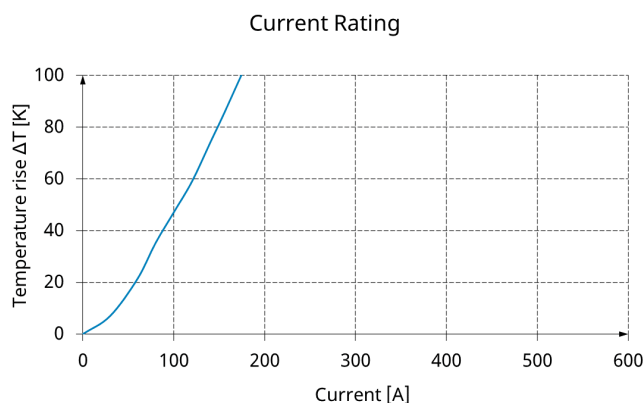
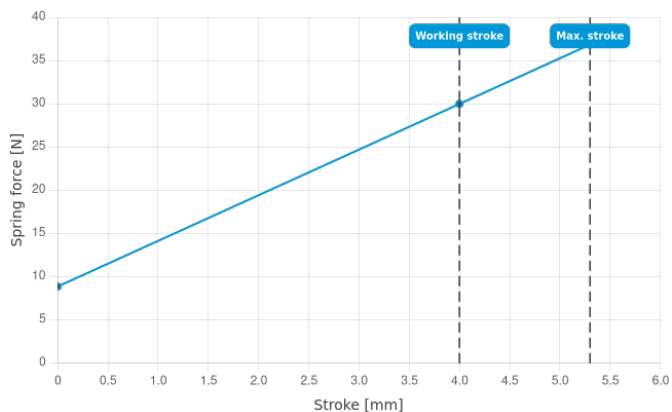

HIGH-CURRENT TEST PROBES

# High-current multi-heads

## HCM-667-0001 C02-05000-02

Item HCM-667-0004



GO TO PRODUCT

# ingun®

Partner for Future Technology

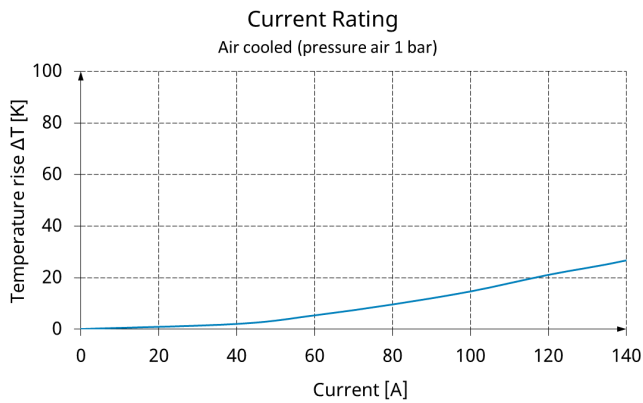

### INGUN Prüfmittelbau GmbH

Max-Stromeyer-Straße 162  
78467, Constance, Germany  
Phone +49 7531 8105-0  
Customer hotline +49 7531 8105-888  
Fax +49 7531 8105-65  
info@ingun.com



Prices and delivery times on request.  
Technical changes reserved. 06/26\_GB

Learn more about  
High-current test probes



HIGH-CURRENT TEST PROBES

ingun.com