

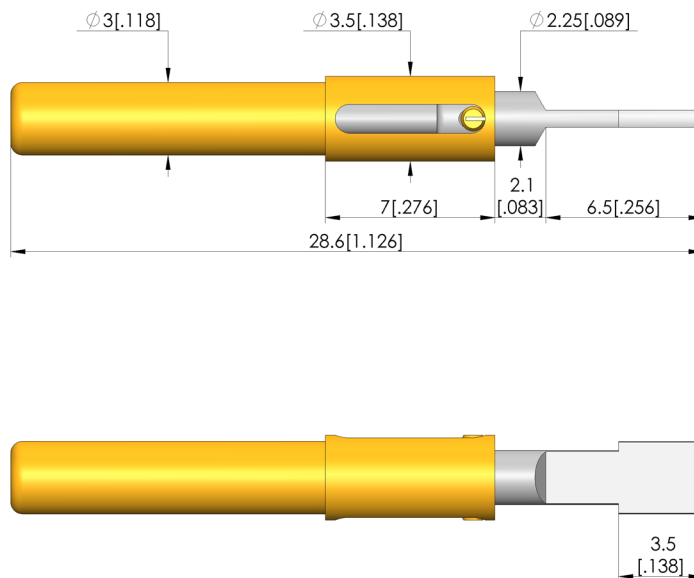

Durchgangsprüfung

Zur Überprüfung von möglichen offenen Verbindungen, Kurzschlüssen und Fehlverdrahtungen

- Für die Kabelbaumprüfung
- Verdreh gesichert

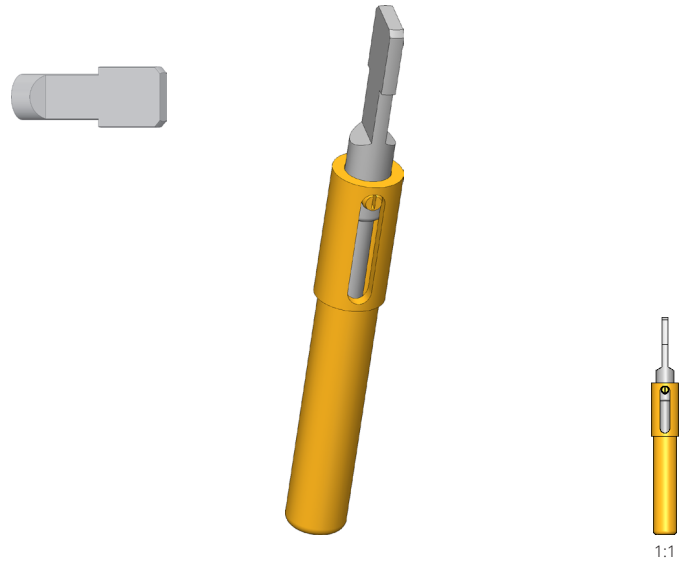

General data

Product group:	xxx
Sub-product group:	Non-rotating test probes
Series:	GKS-098
Grid:	4 mm [157 mil]
Contacting from:	Female connector
Magnetic:	Yes
Installation type:	Plug-in
Quick-exchange system:	Yes
Adjustable installation height:	No
Non-rotating:	Yes
Compatible receptacle(s):	KS-103 23
Min. temperature:	-40 °C [-40 °F]
Max. temperature:	80 °C [176 °F]
RoHS-compliant:	Yes

Tip style data

Tip style:	29 spade, flat with flat head
Tip diameter:	3 mm [.118 in]
Tip style surface:	R rhodium
Tip style material:	3 CuBe
Spade width:	0.7 mm [.027 in]
Spade length:	6.5 mm [.255 in]

Electrical data

Current load capacity / rated current:	10 A
Typical resistance (Ri):	30 mOhm

Mechanical data

Total length:	28.6 mm [1.12 in]
Barrel diameter:	3 mm [.118 in]
Maximum stroke:	5 mm [.196 in]
Spring pre-load:	1.49 N [5.35 ozf]
Collar height:	07
Spring force at working stroke:	5 N [17.9 ozf]
Recommended working stroke:	4 mm [.157 in]

Test Probe

GKS-098 329 300 R 5007

Item GKS-098-0003



GO TO PRODUCT

ingun[®]

Partner for Future Technology

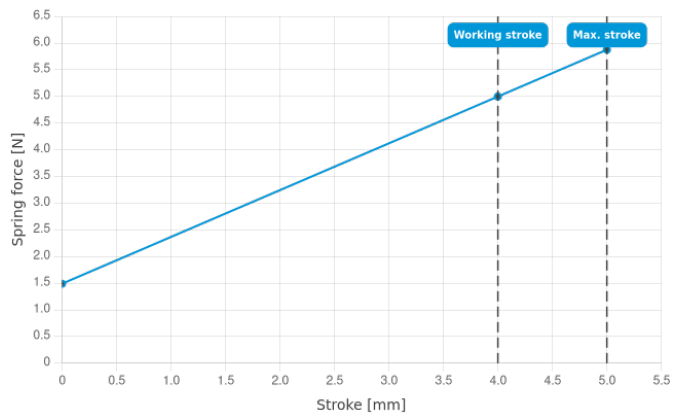

INGUN Prüfmittelbau GmbH

Max-Stromeyer-Straße 162
78467, Constance, Germany
Phone +49 7531 8105-0
Customer hotline +49 7531 8105-888
Fax +49 7531 8105-65
info@ingun.com



Prices and delivery times on request.
Technical changes reserved. 07/26_GB