

High-current multi-heads HCM-667-0012 C01-08000-02

Item HCM-667-0003



GO TO PRODUCT

ingun[®]

Partner for Future Technology

Scaling of current carrying capacity using high-current multi-head solutions

Contacting of battery cells with higher capacities

- Reliable contact of battery cells
- Modular design enables scalability of current transmission using well-established INGUN products
- Increase in maximum current transmission thanks to cooling feature
- Optional cooling of contact surface using GKS-667
- Voltage monitoring via a central sense contact probe possible
- Temperature measurement of contact surface using TKS-667 is an optional addition
- Easy installation in plate or busbar via the threaded connection

Application

The HCMs were specially developed for the flexible scalability of high-current contacting. The modular design makes it possible to adapt the product characteristics to the application, and therefore always provide the right product for a high variable range of DUTs, as is the case with the contacting of battery cells.

Construction

The HCMs each consist of a base body and several high-current test probes which create a parallel circuit. The functionality can be additionally extended using a centrally positioned sense contact probe or temperature measurement probe with integrated sense tap. Optional air-cooling probes, as an alternative to the current-transmitting test probes, are also available.

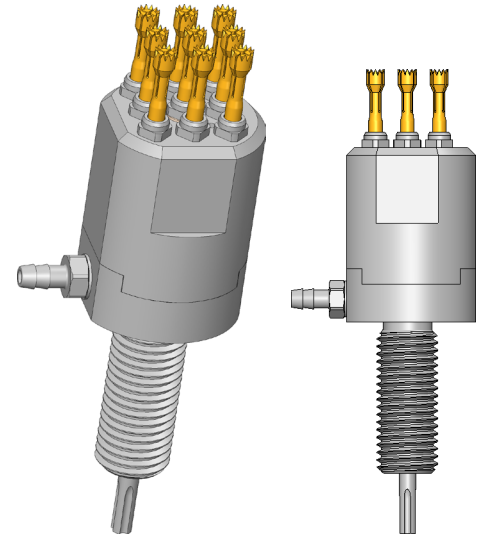
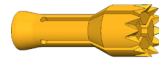

1:1

Installation

The HCMs can be installed in a corresponding hole on a probe plate using lock nuts or installed directly in a busbar via a corresponding threaded hole. If the HCM is installed in a non-conductive plate, for example, the current connection can be made at the threaded bolt using a cable lug. The optional sense contact probe, to be connected to the soldering recess provided, and the temperature sensor are dissipated centrally.

Note:

The base bodies are designed for either five or eight current-transmitting test probes from the HSS-120 and HSS-667 series with various tip styles, which can be freely configured in terms of both quantity and layout. By combining the modular high-current multi-head solution with HSS-667 probes, which were specifically developed for contacting battery cells with oxidised contact surfaces, it is possible to greatly reduce the power losses that occur during cell production.

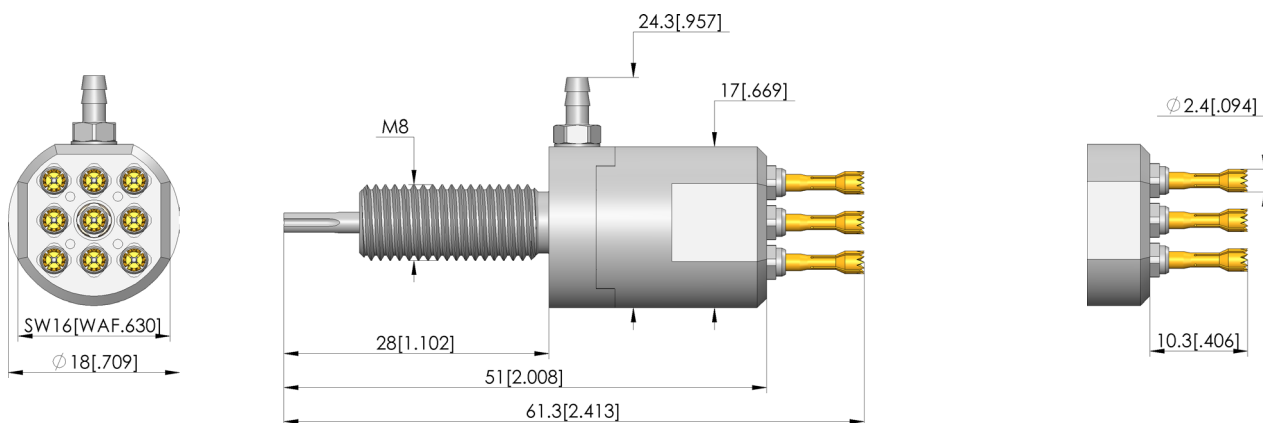

HIGH-CURRENT TEST PROBES

High-current multi-heads

HCM-667-0012 C01-08000-02

Item HCM-667-0003



GO TO PRODUCT

ingun[®]

Partner for Future Technology

General data

Screw-in torque max.:	100 cNm [8.85 lbf-in]
Product group:	Standard HSS (screw-in)
Sub-product group:	Standard HSS (screw-in)
Series:	HCM-667
Application rec.:	
Grid:	19 mm [748 mil]
Contacting from:	-
Magnetic:	Yes
Installation type:	Screw-in
Quick-exchange system:	No
Type of test probe connection:	Thread connection
Adjustable installation height:	No
Non-rotating:	Yes
Screw-in torque:	100 cNm [8.85 lbf-in]
Min. temperature:	-100 °C [-148 °F]
Max. temperature:	200 °C [392 °F]
RoHS-compliant:	Yes

Tip style data

Tip style:	68 expanding tip with front-facing points/cutting edges
Tip diameter:	2.4 mm [.094 in]
Tip style surface:	A gold
Tip style material:	3 CuBe

Electrical data

Current load capacity / rated current:	400 A
Typical resistance (Ri), connection on plunger:	1 mOhm

Mechanical data

Total length:	61.3 mm [2.41 in]
Barrel diameter:	18 mm [.708 in]
Maximum stroke:	5.3 mm [.208 in]
Spring pre-load:	13.32 N [47.9 ozf]
Spring force at working stroke:	45 N [161 ozf]
Recommended working stroke:	4 mm [.157 in]

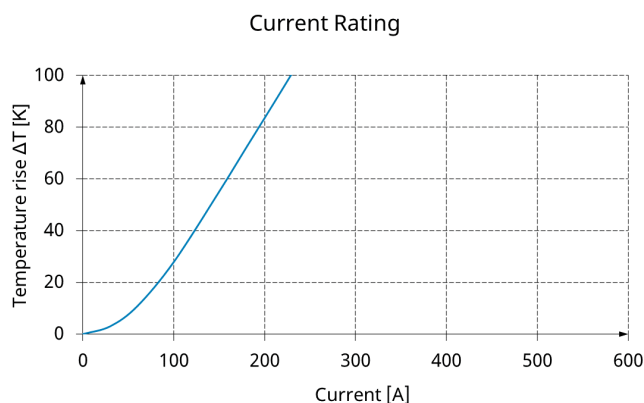
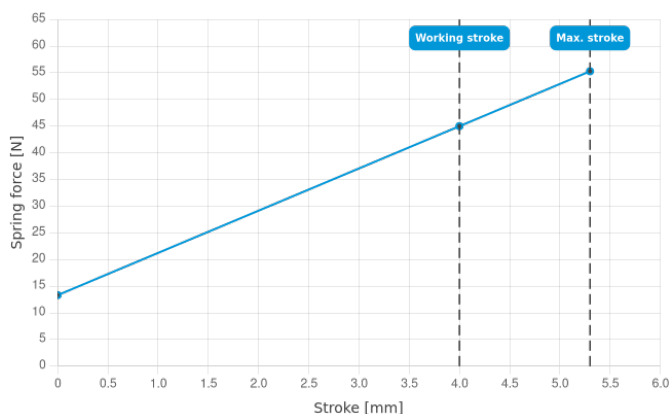

Current Derating

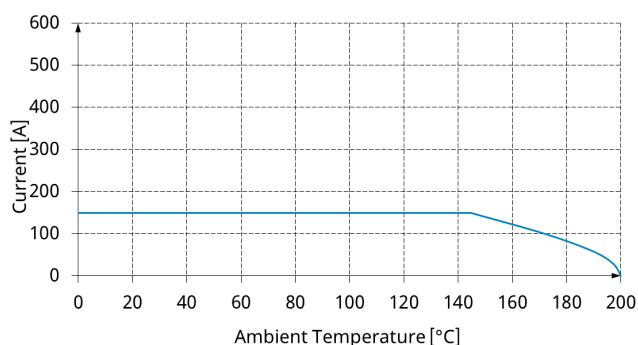

Current Derating

Air cooled (pressure air 1 bar)

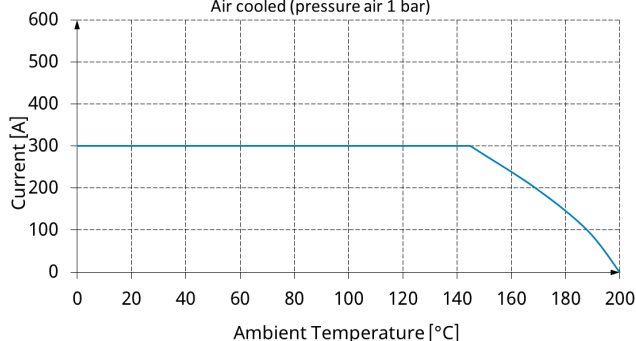

HIGH-CURRENT TEST PROBES

High-current multi-heads

HCM-667-0012 C01-08000-02

Item HCM-667-0003



ingun[®]

Partner for Future Technology

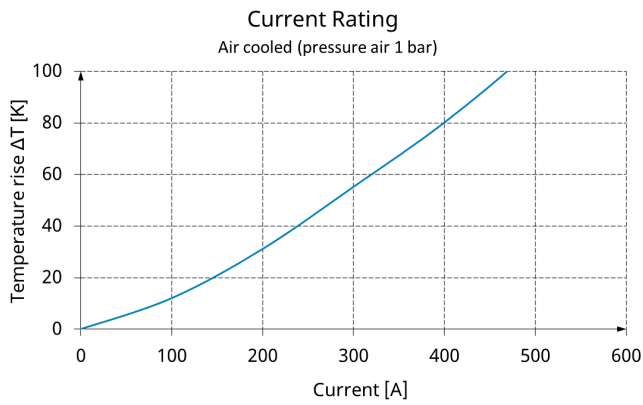

INGUN Prüfmittelbau GmbH

Max-Stromeyer-Straße 162
78467, Constance, Germany
Phone +49 7531 8105-0
Customer hotline +49 7531 8105-888
Fax +49 7531 8105-65
info@ingun.com



Prices and delivery times on request.
Technical changes reserved. 05/26_GB

Learn more about
High-current test probes



HIGH-CURRENT TEST PROBES

ingun.com