

Interface support SSA-VPC-G18-VA4030

Item 115570



GO TO PRODUCT

ingun[®]

Partner for Future Technology

- Interface support für VIRGINIA Panel G18 interface
- Ideally designed for VA 4030 test fixtures
- Quick, easy installation on the back of the test fixture
- Reliable connection from test fixture to system interface

Application

The interface frame (SSA) is used for reliable connection of the interface (SST) to the test fixture.

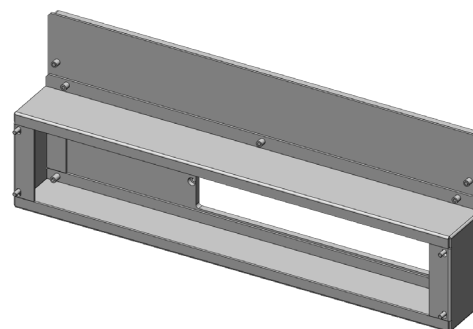

General data

Product group:	Housing
Series:	SSA-VAxxxx
Type:	VPC-G18 (Virginia Panel)
Version:	VA 4030
Accessory type:	Additional function
Scope of delivery:	Unassembled
Width:	66 mm [2.59 in]
Height:	178 mm [7 in]
Weight:	1.3 kg [2.86 lbs]
Min. temperature:	10 °C [50 °F]
Max. temperature:	60 °C [140 °F]
RoHS-compliant:	Yes

Compatible with

Vacuum test fixtures (VA):	VA 4030
Accessories:	SST-VPC-G18

Technical data

Length:	458 mm [18 in]
Outer dimensionS (WxDxH):	458 x 66 x 178 mm [18 x 2.59 x 7 in]

INGUN Prüfmittelbau GmbH

Max-Stromeyer-Straße 162
78467, Constance, Germany
Phone +49 7531 8105-0
Customer hotline +49 7531 8105-888
Fax +49 7531 8105-65
info@ingun.com



Prices and delivery times on request.
Technical changes reserved. 05/26_GB

Learn more about
Test fixture kits

