

Desk housing PGH MA13/TDS/BG

Item 114904



GO TO PRODUCT

ingun[®]

Partner for Future Technology

Application

Desk housing for vacuum test fixtures MA xxxx for modular test fixture configuration.

Version

Closed base, without rear panel

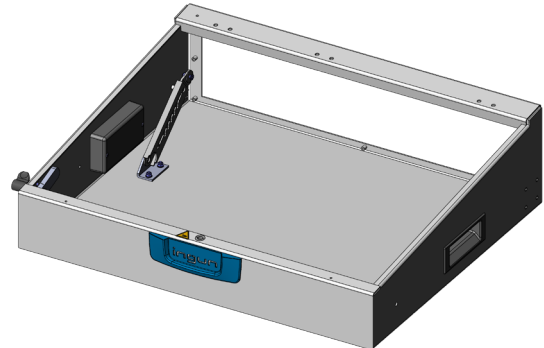

General data

Product group:	Housing
Series:	PGH-MAxxxx
Type:	MA xx13
Version:	Desk housing with KSG, TDS, base plate
Accessory type:	Additional function
Scope of delivery:	Unassembled
Material:	3.3535
Width:	648 mm [25.5 in]
Height:	178 mm [7 in]
Weight:	3.2 kg [7.05 lbs]
Min. temperature:	10 °C [50 °F]
Max. temperature:	60 °C [140 °F]
RoHS-compliant:	Yes

Compatible with

Manual test fixtures (MA): MA xx13

Technical data

Length: 521 mm [20.5 in]
Outer dimensionS (WxDxH): 648 x 521 x 178 (105) mm

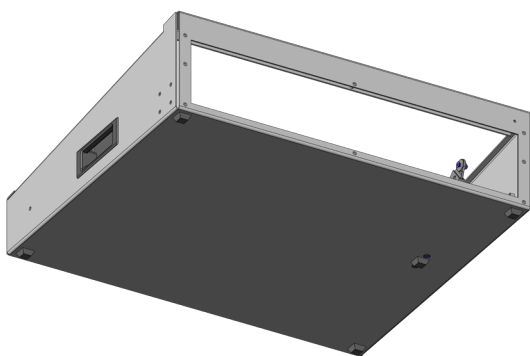

INGUN Prüfmittelbau GmbH

Max-Stromeyer-Straße 162
78467, Constance, Germany
Phone +49 7531 8105-0
Customer hotline +49 7531 8105-888
Fax +49 7531 8105-65
info@ingun.com



Prices and delivery times on request.
Technical changes reserved. 05/26_GB

Learn more about
Test fixture kits

